

This print and associated documents and the contained information are the confidential property of ELECTRONIC CABLE SPECIALISTS. Disclosure of, and/or reproduction of, all or part thereof or manufacture of any part from information contained on this print not specifically permitted by ELECTRONIC CABLE SPECIALISTS in writing is forbidden.

INSTALLATION INSTRUCTIONS

REVISIONS					
ECN	ZONE	REV.	DESCRIPTION	DATE	APPROVED
31294	-	N/C	NEW RELEASE	12/20/07	D.KNOLL
81234	B3 A4	A	UPDATED NOTE 4 CRIMP DIE CALLOUT MATERIAL SPECS UPDATED		

- BEGIN BY CUTTING THE CABLE OFF SQUARE.

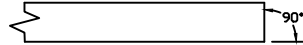

- WHEN USING AUTOMATIC STRIPPING EQUIPMENT, STRIP CABLE AS SHOWN STARTING WITH L1 AND ENDING WITH L3. TAKE CARE NOT TO NICK THE CONDUCTORS WHILE STRIPPING THE DIELECTRIC AND JACKET. IF AUTOMATIC STRIPPING EQUIPMENT IS NOT AVAILABLE, STRIP ONLY L1 AND L3 AND TRIM EXCESS BRAID AT STEP 10.

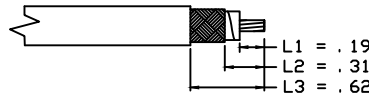

- SLIDE THE FERRULE AND ADHESIVE SHRINK TUBING OVER THE END OF THE CABLE.

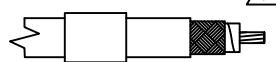

- SOLDER THE CONTACT ONTO THE CENTER CONDUCTOR, PER MIL-STD-2000, USING 63Sn/37Pb SOLDER OR CRIMP WITH M22520/5-06 DIE (A HEX). ENSURE THE CONTACT IS BUTTED AGAINST THE CABLE DIELECTRIC. CLEAN ALL FLUX RESIDUES USING AN APPROPRIATE FLUX CLEANER.

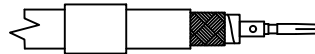

- USING TWEEZERS, FOLD THE OUTER BRAID BACK OVER THE CABLE JACKET, LEAVING AS MUCH WEAVE AS POSSIBLE.



- SLICE THE ALUMINUM/POLYESTER FOIL LENGTHWISE ABOUT EVERY 1/8". GENTLY ROTATE PIN TO SEPARATE THE FLAT FOIL BRAID AND ALUMINUM/POLYESTER FOIL FROM THE DIELECTRIC. USING TWEEZERS, FOLD BACK ALUMINUM/POLYESTER FOIL OVER THE OUTER BRAID.



- USING TWEEZERS, FOLD THE INNER BRAID BACK OVER THE OTHER SHIELDS, LEAVING AS MUCH WEAVE AS POSSIBLE. NOTE: DO NOT UNRAVEL DIELECTRIC WHEN PULLING BACK INNER SHIELD.



- SLIDE THE BODY OF THE CONNECTOR OVER THE END OF THE CABLE UNTIL THE NOTCH IN THE CONTACT SEATS WITH THE DIELECTRIC RIDGE INSIDE THE CONNECTOR BODY.

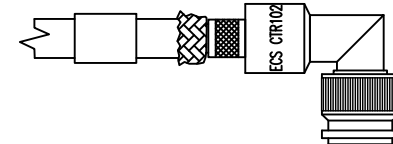

- FOLD ALL THREE BRAIDS UP OVER THE NECK OF THE CONNECTOR BODY.

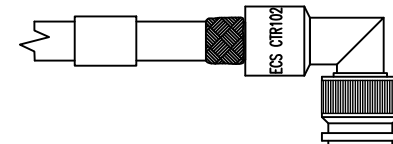

- SLIDE THE FERRULE UP OVER THE SHIELDS AND AGAINST THE CONNECTOR BODY. TRIM AWAY ANY EXCESS BRAID. CRIMP THE FERRULE ONCE, NEXT TO THE BODY, USING THE M22520/5-51 DIE IN A M22520/5-01 TOOL FRAME. APPLY ADHESIVE HEAT SHRINK.

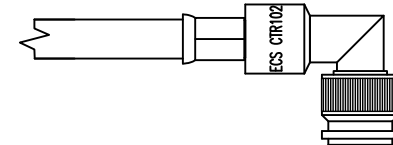

NOTES

- 1 ENSURE HEAT SHRINK IS INSTALLED PRIOR TO CRIMPING CONNECTOR.
- 2 ADHESIVE HEAT SHRINK SHOULD BE APPLIED IN ACCORDANCE WITH ECS WORK INSTRUCTION W1007. CONTACT ECS FOR A COPY OF THIS WORK INSTRUCTION.
- 3 CONNECTOR DIMENSIONS ARE FOR REFERENCE ONLY.

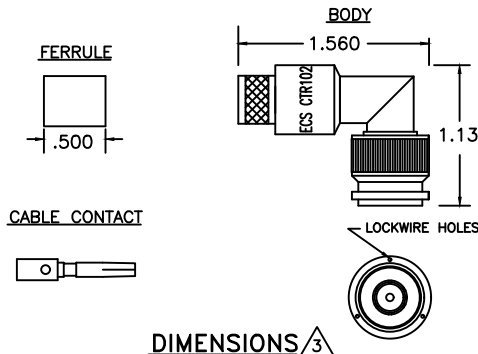

SPECIFICATIONS

ELECTRICAL
 IMPEDANCE: 50 OHMS NOMINAL
 FREQUENCY RANGE: 0-11 GHz
 VSWR: 1.2:1 MAXIMUM DC TO 2GHz
 INSERTION LOSS: .1dB MAXIMUM DC TO 2GHz
 WORKING VOLTAGE: 500 VRMS @ SEA LEVEL
 DIELECTRIC WITHSTANDING: 1500 VRMS @ SEA LEVEL
 INSULATION RESISTANCE: 5000 MEGOHMS MINIMUM @ 500 VOLTS DC

MECHANICAL
 CONNECTOR INTERFACE: DIMENSIONS PER MIL-STD-348A FIGURE 313-1 (TNC)
 TERMINATION STYLE: CABLE CONTACT-SOLDER OR CRIMP FERRULE-CRIMP
 CABLE RETENTION: 50 LBS

ENVIRONMENTAL
 TEMPERATURE RATING: -65° TO +165° C
 VIBRATION: MIL-STD-202, METHOD 204, COND. B
 SHOCK: MIL-STD-202, METHOD 213, COND. I
 THERMAL SHOCK: MIL-STD-202, METHOD 107, COND. B
 CORROSION: MIL-STD-202, METHOD 101, COND. B
 MOISTURE RESISTANCE: MIL-STD-202, METHOD 106

MATERIALS
 BODY: BRASS PER ASTM B16
 FERRULE: ANNEALED, BRASS PER ASTM B16 OR COPPER PER ASTM B124
 CABLE CONTACT: BERYLLIUM COPPER PER ASTM B196
 CENTER CONTACT: BRASS PER ASTM B16
 OUTER CONTACT: BERYLLIUM COPPER PER ASTM B196
 DIELECTRIC: TEFLON PER ASTM D1710
 GASKET: SILICONE RUBBER PER A-A-59588

FINISHES
 BODY, FERRULE AND OUTER CONTACT: BRIGHT NICKEL PER SAE AMS-QQ-N-290
 CONTACTS: GOLD PER MIL-DTL-45204

ALL LENGTHS IN INCHES		ECS		ELECTRONIC CABLE SPECIALISTS FRANKLIN, WI 53132 PHONE: (414) 421-5300	
APPROVALS	DATE	TITLE: CUSTOMER SPECIFICATION			
DRAWN BY: C. CHAPMAN	12/19/07	TNC RIGHT ANGLE PLUG FOR ECS CABLE 311001			
CHECKED BY: D. KNOLL	12/20/07	SIZE	CAGE CODE	LEVEL	PART NO.
DESIGNED BY:		B	66197		CTR102
PROJECT ENG:		SCALE:		FILE NO	SHEET: 1 OF 1
ENG. MGR: D. KNOLL	12/20/07	F:\EVSPEC\CONN\INST\CTR102			